



无框架-一字支架 92x92x25mm-2

马达可选功能列表 (Available Functions)

1. 马达保护 (Moto protection)

AS

2. 信号输出 (Signal out put)

FG RD

3. 调速方式 (Speed control mode)

PWM



风扇单重: 35g (weight: 35g)

风扇P-Q曲线 / Fan performance curve

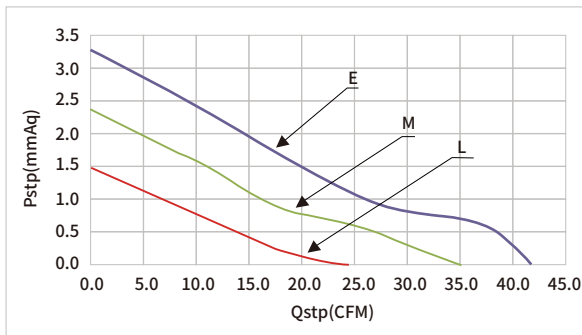

尺寸图 / DIMENSIONS DRAWING

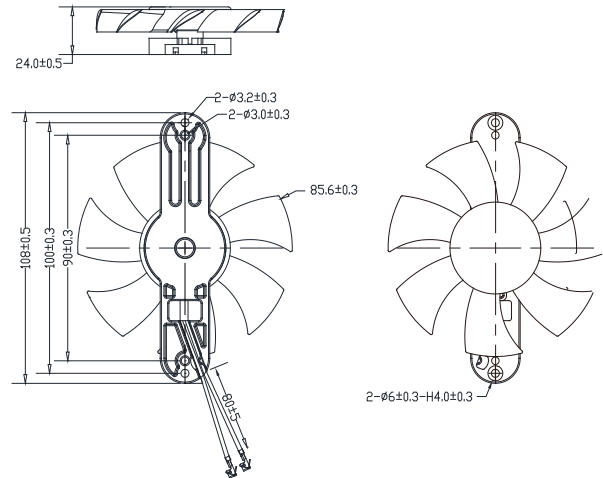

Model		Bearing	Rated Voltage	Startup Voltage	Current	Power	Speed	Air Flow		Static Pressure		Noise
型号	功能	轴承	工作电压	启动电压	电流	功率	转速	风量	风量	风压	风压	噪音
Part NO.	Function	System	VDC	VDC	A	W	RPM	M ³ /min	CFM	mmH ₂ O	INH ₂ O	dBA
HYB0912HA-2		Sleeve /Ball	12	6.0	0.23	2.76	2800	1.21	42.74	3.27	0.13	34.6
HYB0912MA-2				6.0	0.19	2.28	2400	1.02	35.97	2.36	0.09	31.4
HYB0912LA-2				6.0	0.16	1.92	2000	0.70	24.88	1.48	0.06	29.6